

Bringing your  
home to life



**safeGUARD**  
COMPOSITE DOORS

# Our most popular door styles

For the full range visit our door designer... [door-designer.co.uk/safeguard](http://door-designer.co.uk/safeguard)

Alnwick



Page 6

Bowes



Page 8

Balmoral



Page 10

Caernarfon



Page 10

Rochester



Page 10

Edinburgh



Page 12

Richmond



Page 12

Leeds



Page 14

Conwy



Page 16

Durham



Page 18

Pembroke



Page 20

Hailes



Page 16

Elder



Page 24

Holly



Page 26

Beech



Page 28

Stable Doors



Page 30

Porto



Page 32

Rome



Page 32

Athens



Page 33

Milan

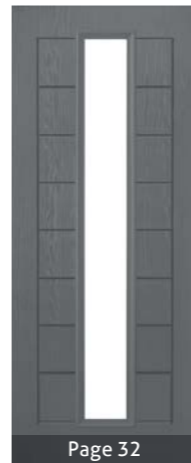

Page 32

Vienna



Page 33

Lancaster

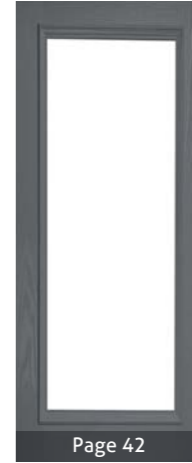

Page 42

Somerton



Page 34

Morton



Page 35

Wark



Page 36

Skipton



Page 37

Orford



Page 38

Etal



Page 39

Astley



Page 40

Balmoral Solid



Page 41

Alnwick Solid



Page 41

Sherbourne Solid



Page 41

Appleby



Page 41

Willow



Page 41

Prestige  
Colour  
Range  
Page 45



# Why SafeGuard?

SafeGuard composite doors are one of the UK's leading brands of residential doors, manufactured and assembled using only the best of components, you can rest assured these hand built doors are amongst the best available.

## ✓ Exceptional Durability

High impact resistant glass reinforced polyester (GRP) skin that will maintain its pristine appearance.

## ♥ Stunning Aesthetics

The woodgrain finish was developed from oak tree grain. You'll also find the same woodgrain effect and moulding design on the slim glazing cassette, giving a seamless and authentic finish.

## ↓ Low Maintenance

Everything about our GRP composite door is designed to be easy to maintain - simply wipe clean with warm soapy water.

Read about door maintenance on page 51.

## 💧 Excellent Weatherproofing

With water resistant polymer composite rails, our doors will keep the weather at bay and will stay looking great for longer.

## 🔒 Unparalleled Security

Our GRP composite doors offer enhanced security thanks to its rigid polymer sub-frame, high density insulated core and high impact resistant GRP skin. Rest assured that our doors are tried, tested and trusted, keeping you and your family safe.

See our hardware ranges on page 46 - 49.

## 📄 Triple Glazed Glass

Our triple glazed, laminated as standard insulated glass units encapsulate the decorative glazing between two panes of clear glass, protecting it and making it easy to keep clean.

Read more about our glass on page 22.

## 🔊 Superb Sound Insulation

With a weighted noise reduction of 31 decibels it means you can be sure your new door will keep outside noise to a minimum.

See more technical information on page 50.



Look for the indicative rating on each page



When it comes to thermally efficient doors, a SafeGuard GRP composite door is the best choice you can make.

These days, we all worry about how much energy our homes use. The rising cost of our energy bills and our impact on the environment mean we want to keep our consumption to a minimum. One of the best ways to do this is to choose thermally efficient products that keep warmth in and cold out, saving money and emissions.

The alphabetical, colour coded scales shown in this brochure follow the same grading system as that found in white goods with 'A' representing the most energy efficient.

The testing shows the thermal efficiency of each of the doors. The darker the blue, the less heat is being lost. Reds and greens – the predominant colours on the timber door – indicate high heat loss.

Doors were tested at the University of Salford's Energy

House. This represents a typical Salford 1919 terraced house and its construction represents 21% of the UK's current housing stock.

The house has been reconstructed in a fully environmentally controllable chamber, in which climatic conditions can be maintained, varied, repeated and patterns monitored. For the test, the inside temperature of the Energy House was 25°C with an exterior temperature of 5°C.



# Alnwick



Alnwick Door in Light Grey with Edwardian Glass



Alnwick Door in Duck Egg with Trieste Glass



Alnwick Door in Mouse Grey with Kara Green Glass



Alnwick Door in Steel Blue with Aspen Glass

## Choose the Alnwick...

The twin top glazing adds sophistication to this already classic design whilst maintaining privacy and that feeling of security. For that ultimate feeling of security why not choose the Alnwick Solid with its six featured panels offering a safe and secure feeling to any home.



## Glass



Andorra  
Zinc or Brass Caming.

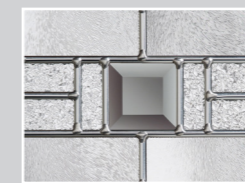

Aspen



Edwardian



Kara  
Glass with Zinc or Brass Caming. Red/Blue/Green/Grey - Zinc only.



Lunna



Monza



Palma



Savana



Scotia  
Zinc or Brass Caming.



Sierra



Trieste



Valentia

# Bowes



Bowes Door in Mouse Grey with Kara Zinc Glass



Bowes Door in Ruby Red with Palma Glass

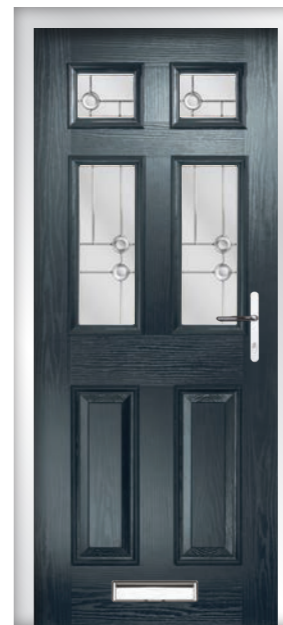

Bowes Door in Anthracite with Trieste Glass



Bowes Door in White with Andorra Glass

Let us inspire you with our selection of Standard and Prestige colours.

Specially chosen for you.

Available on any of our Traditional and Contemporary doors (see pages 44 - 45 for the full colour range).



Heritage Chartwell



Heritage Anthracite

## Glass

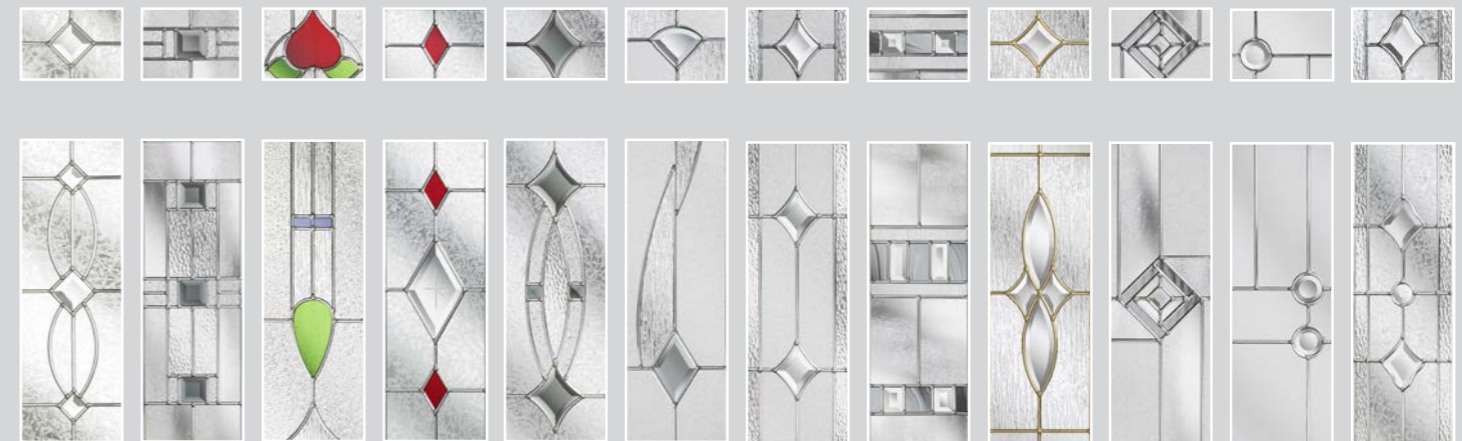

Andorra  
Zinc or Brass  
Caming.

Aspen

Edwardian

Kara  
Glass with Zinc  
or Brass Cam-  
ing. Red/Blue/  
Green/Grey -  
Zinc only.



Lunna

Monza

Palma

Savana

Scotia  
Zinc or  
Brass  
Caming.

Sierra

Trieste

Valentia



# Balmoral | Caernarfon | Rochester



Caernarfon Door in Chartwell with Monza Glass



Rochester Door in Anthracite with Edwardian Glass



Balmoral Door in Red with Andorra Glass



Caernarfon Door in White with Savana Glass

A SafeGuard composite door is more energy efficient than a traditional timber door or a solid timber core composite door fact!

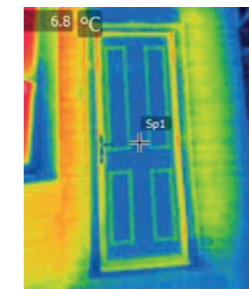

Look out for the A - C indicative energy ratings. Read more on page 5.

## Glass



Andorra  
Zinc or Brass  
Caming.

Aspen

Edwardian

Kara

Lunna

Monza

Palma

Savana

Scotia  
Zinc or  
Brass  
Caming.

Sierra

Trieste

Valentia

Glass with Zinc or Brass Caming. Red/Blue/Green/Grey - Zinc only.



Colours shown should be used for guidance only as the limitations in the printing process may mean that colours vary from those illustrated.

# Edinburgh



Decorative backing glass and clear bevels



Richmond Door in White with Satin Glass

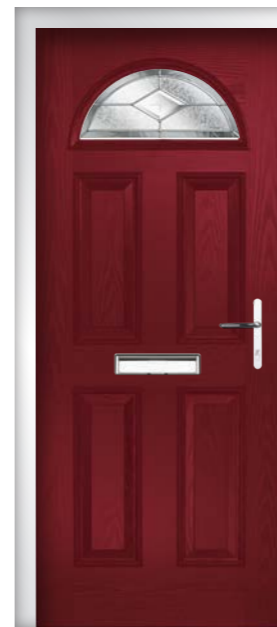

Edinburgh Door in Ruby Red with Kara Grey Glass



Edinburgh Door in Chartwell with Lunna Glass



Edinburgh Door in Sable with Sierra Glass

## Safe and Secure

All SafeGuard composite doors are fitted with a top quality multipoint locking system as standard and have been tested under stringent independent conditions against 'intruder attack'.

Read more on page 48 - 49!

**ULTION**

Secured by Design



Official Police Security Initiative

## Glass



Andorra  
Zinc or Brass Caming.

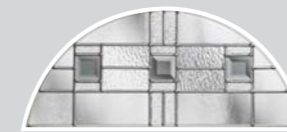

Aspen



Edwardian



Kara  
Glass with Zinc or Brass Caming. Red/Blue/Green/Grey - Zinc only.

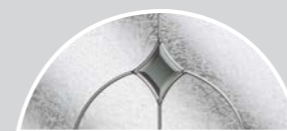

Lunna



Monza



Palma

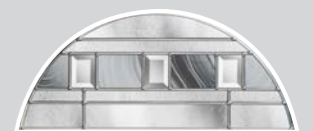

Savana



Scotia  
Zinc or Brass Caming.



Sierra



Trieste



Valentia

Colours shown should be used for guidance only as the limitations in the printing process may mean that colours vary from those illustrated.

# Leeds



Leeds Door in Black with Monza Glass



Leeds Door in Signal Violet with Valentia Glass

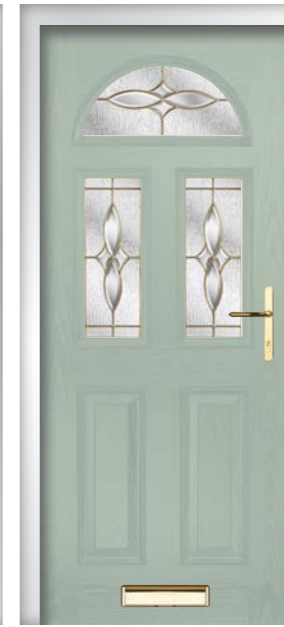

Leeds Door in Chartwell with Scotia Brass Glass



Leeds Door in Distant Blue with Aspen Glass

**19% More**  
thermally efficient than  
a 48mm solid timber  
core composite door.

**17% More**  
thermally efficient than  
a 44mm traditional  
timber panelled door.

## Glass



Andorra  
Zinc or Brass Caming.



Aspen



Edwardian

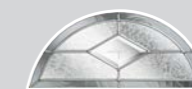

Kara  
Glass with Zinc or Brass  
Caming. Red/Blue/Green/  
Grey - Zinc only.

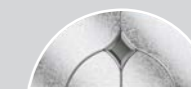

Lunna

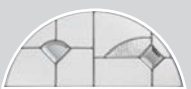

Monza

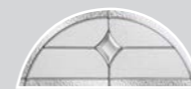

Palma



Savana



Scotia  
Zinc or Brass Caming.

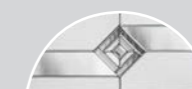

Sierra



Trieste



Valentia



# Conwy

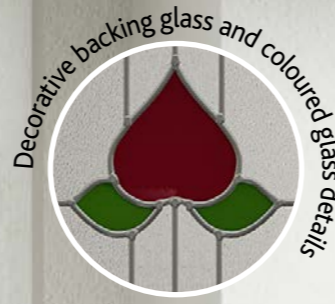

Decorative backing glass and coloured glass details



Hailes Door in Anthracite with Kara Brass Glass    Conwy Door in Silk Grey with Savana Glass    Conwy Door in Ruby Red with Palma

An enclosed mini-blind is the perfect solution for controlling light in your home.

The blind and mechanism are totally enclosed between two panes of glass, therefore completely protected from potential damage and dust. Controlled using a tab rather than a traditional cord, means they are completely safe for use around children.



Conwy Door in White with Mini Blind

## Glass

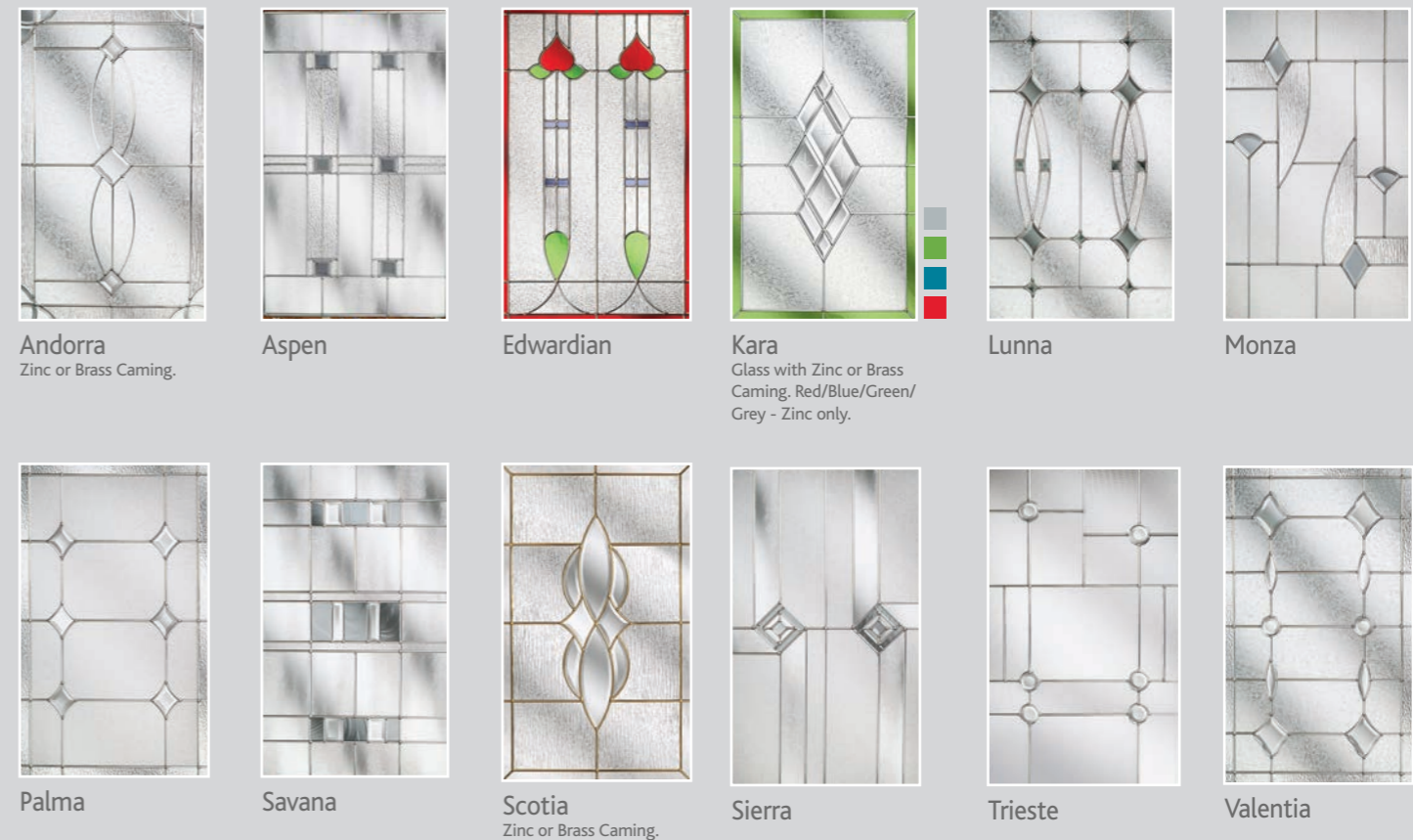

Andorra  
Zinc or Brass Caming.

Aspen

Edwardian

Kara  
Glass with Zinc or Brass Caming. Red/Blue/Green/Grey - Zinc only.

Lunna

Monza

Palma

Savana

Scotia  
Zinc or Brass Caming.

Sierra

Trieste

Valentia

# Durham

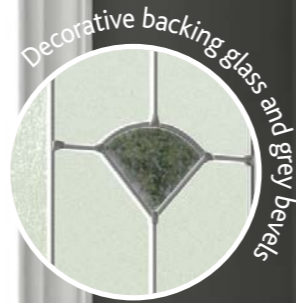

Decorative backing glass and grey bevels



Durham Door in Azure Blue with Savana Glass



Durham Door in Colza Yellow with Sierra Glass



Durham Door in Signal Violet with Scotia Glass



Durham Door in Mouse Grey with Kara Blue Glass

Visit our door designer to configure your perfect door style...

[door-designer.co.uk/safeguard](http://door-designer.co.uk/safeguard)

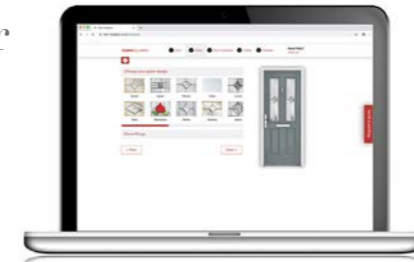

## Glass



Andorra  
Zinc or Brass Caming.



Aspen

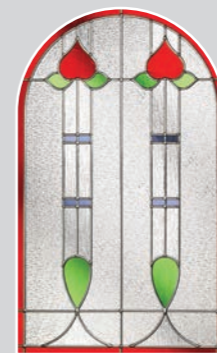

Edwardian



Kara  
Glass with Zinc or Brass Caming. Red/Blue/Green/Grey - Zinc only.



Lunna



Monza



Palma



Savana



Scotia  
Zinc or Brass Caming.



Sierra



Trieste



Valentia

Colours shown should be used for guidance only as the limitations in the printing process may mean that colours vary from those illustrated.



# Pembroke



Decorative backing glass and coloured glass details



Pembroke Door in Green Mist with Aspen Glass



Pembroke Door in Ruby Red with Kara Brass Glass



Pembroke Door in Green with Palma Glass



Pembroke Door in Light Grey with Monza Glass

Hardware manufactured to the highest of standards.

View the range on pages 46 - 49



## Glass



Aspen



Edwardian

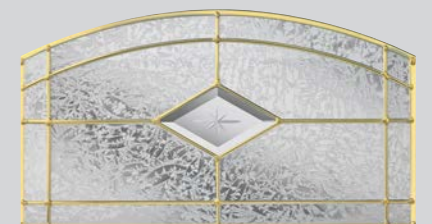

Kara  
Brass Caming.



Monza

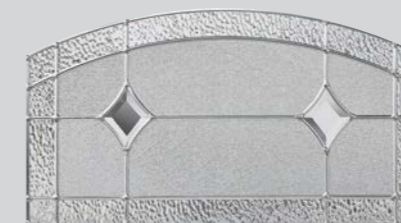

Palma

# Glass Collection



**The ultimate finishing touch for your door...**

- ✓ 12 stunning styles of glazing
- ✓ Triple glazed
- ✓ The encapsulated decorative pane means the design stays looking beautiful for longer
- ✓ Easy to maintain, no bevels or comes to clean
- ✓ 6.8mm Laminated glass for extra security



**Andorra** Brass or Zinc



**Aspen**



**Edwardian**



**Kara** Brass, Zinc or Zinc colours



**Lunna**



**Monza**



**Palma**



**Savana**



**Scotia** Brass or Zinc

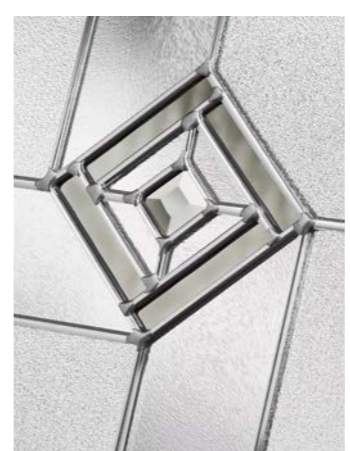

**Sierra**

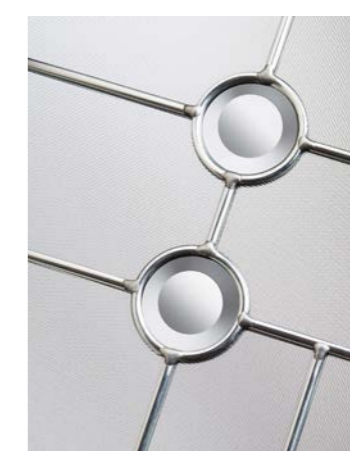

**Trieste**



**Valentia**

## Glass Construction

### Features and benefits:

- Decorative triple glazing
- Protected from dust and weathering, easy to clean and stays looking good for longer
- Tested and CE marked
- 6.8mm glass laminated as standard on triple glazing

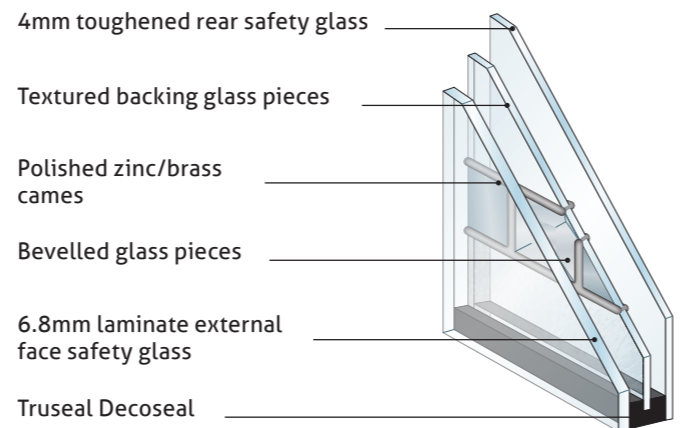

Colours shown should be used for guidance only as the limitations in the printing process may mean that colours vary from those illustrated.

# Elder



Elder Door in Mouse Grey with Aspen Glass



Elder Door in Ruby Red with Palma Glass



Elder Door in Chartwell with Scotia Brass Glass



Elder Door in Anthracite Grey with Monza Glass

## Exclusively decorative glass range designed to enhance your door

The decorative glass design is encapsulated between two clear panes, one laminated and one toughened. Not only does this strengthen the panel, it also protects it from dust, making it exceptionally easy to clean.

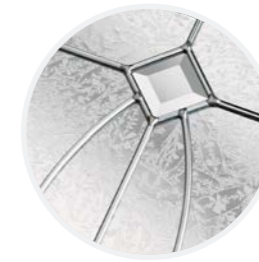

### Glass



Andorra  
Zinc or Brass Caming.

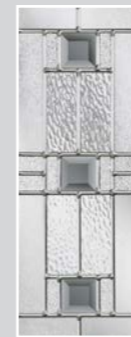

Aspen

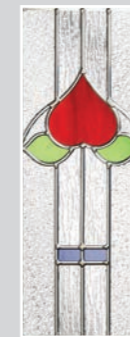

Edwardian



Kara  
Glass with Zinc or Brass Caming. Red/Blue/Green/Grey - Zinc only.



Lunna



Monza



Palma



Savana



Scotia  
Zinc or Brass Caming.



Sierra



Trieste



Valentia

# Holly



Holly Door in Wine Red with Kara Brass Glass



Holly Door in Distant Blue with Lunna Glass



Holly Door in Mouse Grey with Edwardian Glass



Holly Door in Chartwell with Savana Glass

All SafeGuard doors offer high quality protection for your home...

As well as beauty that's much more than skin deep. The richly grained finish is extremely durable, with a look and feel of traditional timber door – but requires only minimal maintenance.



## Glass

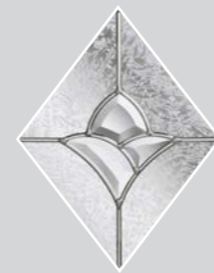

Andorra  
Zinc or Brass Caming.

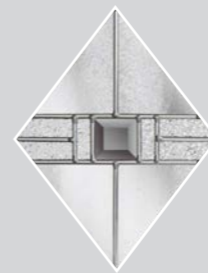

Aspen



Edwardian

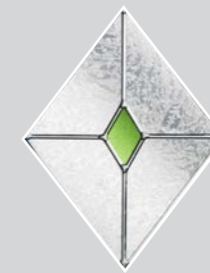

Kara  
Glass with Zinc or Brass Caming. Red/Blue/Green/Grey - Zinc only.

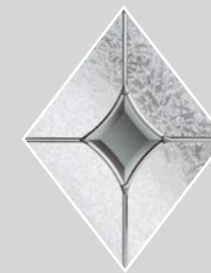

Lunna

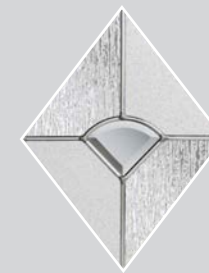

Monza



Palma



Savana

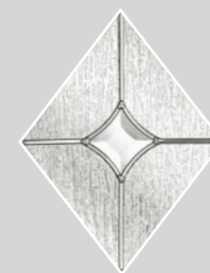

Scotia  
Zinc or Brass Caming.



Sierra



Trieste



Valentia

Colours shown should be used for guidance only as the limitations in the printing process may mean that colours vary from those illustrated.



# Beech

WESTERFIELD HOUSE

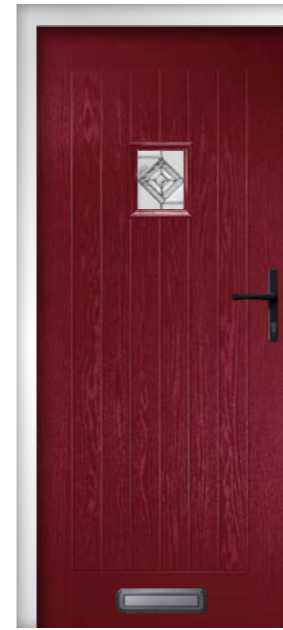
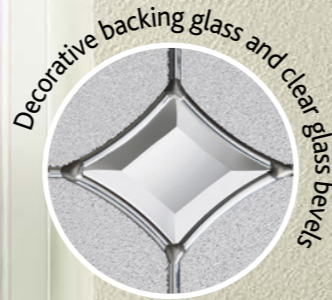
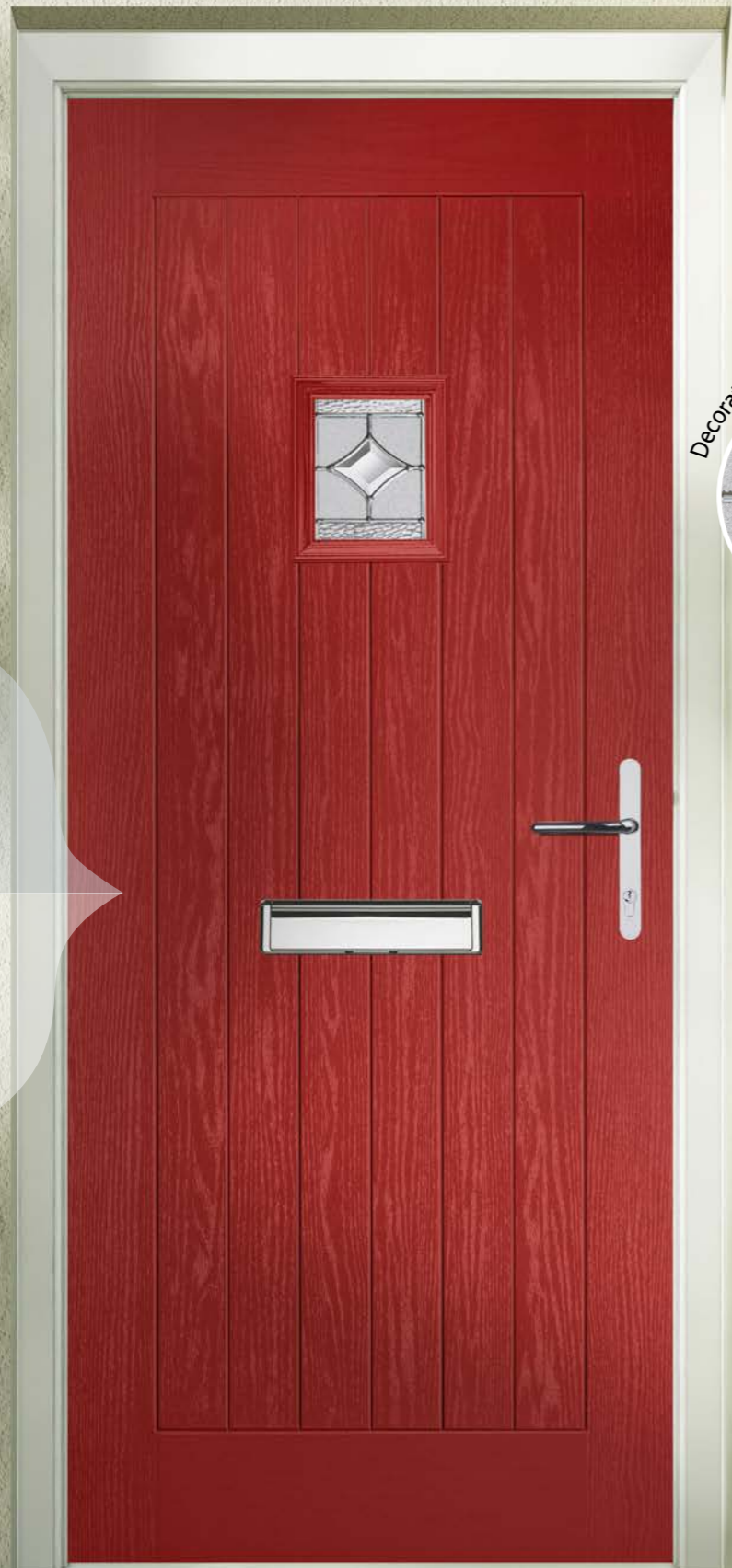

Beech Door in Ruby Red with Sierra Glass



Beech Door in Leaf Green with Andorra Zinc Glass



Beech Door in Light Grey with Trieste Glass



Beech Door in Steel Blue with Aspen Glass

For the ultimate finishing touch choose from one of our extensive decorative glass ranges

From traditional to modern styles, the choice is vast. We offer triple glazed units for high performance heat and sound insulation.



## Glass



Andorra  
Zinc or Brass Caming.

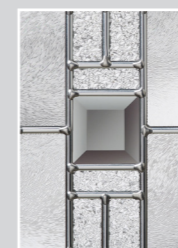

Aspen



Kara  
Glass with Zinc or Brass Caming. Red/Blue/Green/Grey - Zinc only.



Lunna

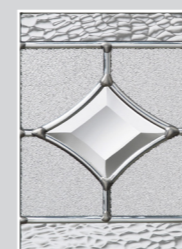

Palma



Scotia  
Zinc or Brass Caming.



Sierra



Trieste

Colours shown should be used for guidance only as the limitations in the printing process may mean that colours vary from those illustrated.

# Stable Doors



Kempton Door in Sable with Savana Glass

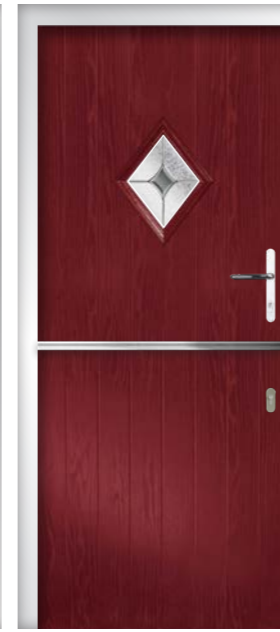

Haydock Door in Red with Lunna Glass



Epsom Door in Chartwell with Trieste Glass



Kempton Door in Mouse Grey with Valentia Glass

Designed to give a traditional look to a high-performance GRP door product.

SafeGuard stable doors look great as either a front or rear entrance and will give you plenty of ventilation when needed.



For more glass options, see page 24 - 29





# City Collection

**new**

Our City Collection doors are an eagerly anticipated addition to our already popular contemporary range.

Five on-trend grooved door styles that are sure to make a statement on your home.

Featured is the Rome door in Anthracite Grey, with Stainless hardware.

To bespoke your design visit our door designer...  
[door-designer.co.uk/safeguard](http://door-designer.co.uk/safeguard)



# City Collection

These modern doors will flood light into your home and give your house a fantastic kerb appeal. The glazing can be located centrally, or to the left or right the choice is yours.

Shown Left is the Milan door, in Mouse Grey with Radiant glass, and Stainless hardware.

More configurations available online...  
[door-designer.co.uk/safeguard](http://door-designer.co.uk/safeguard)



Porto Door in Green



Rome Door in Traffic Grey A



Vienna Door in Sable With Aspen glass

See page 29 for more glass!

## Configurations



Nice



Lisbon

## Configurations



Paris



Berlin

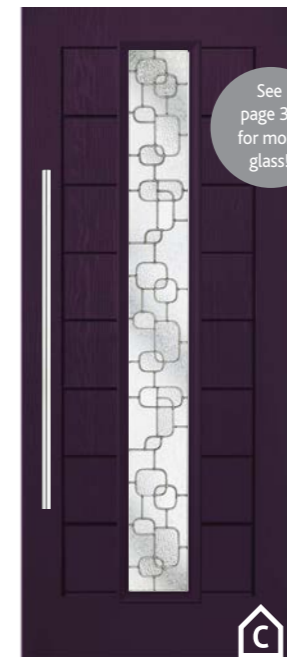

Milan Door in Purple Violet with Canvas Glass

See page 36 for more glass!



Athens Door in Red Violet

# Somerton

This ultra modern door style has five glazing apertures that form a curve around the handle side of the door.

Shown here is our Somerton door style, with Glacier glass in Anthracite Grey. Featuring stainless hardware.

**Flush doors:**  
Somerton | Curved glass

To bespoke your design visit our door designer...  
[door-designer.co.uk/safeguard](http://door-designer.co.uk/safeguard)



# Morton

One of our most popular contemporary designs the Morton has its four glazing apertures centrally aligned.

Displayed left is the Morton door style in White, with Odessa glass and stainless hardware.

**Flush doors:**  
Morton | Central glass  
Dunster | Hinge aligned  
Arundel | Handle aligned

**Planked doors:**  
Burton | Central glass  
Stroud | Hinge aligned  
Didcot | Handle aligned

To bespoke your design visit our door designer...  
[door-designer.co.uk/safeguard](http://door-designer.co.uk/safeguard)



Breeze



Glacier



Andorra

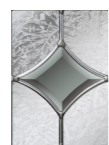

Lunna



Sierra



Aspen



Monza



Trieste

## Configurations



Somerton

## Configurations



Morton



Arundel



Dunster



Burton



Didcot



Stroud

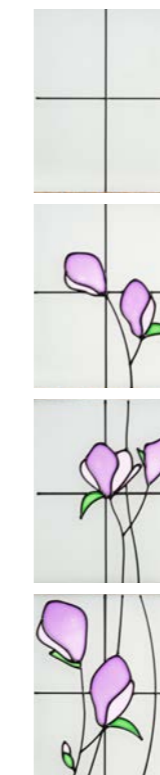

Bloom



Odessa



Andorra

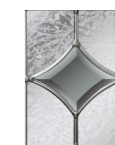

Lunna



Sierra



Aspen



Monza



Trieste

# Eye

Sleek and minimal this door design, creates a lasting statement. Available in three configurations.

The Eye door is shown here in Signal Violet, with Canvas glazing and stainless hardware.

## Flush doors

Wark | Central glass  
Eye | Hinge aligned  
Peil | Handle aligned

To bespoke your design visit our door designer...  
[door-designer.co.uk/safeguard](http://door-designer.co.uk/safeguard)



# Skipton

A modern design that creates lots of personality. Plus choose from the statement glass to make it your own.

This Skipton door is shown with Eclipse glass, in Mouse Grey, featuring Brass hardware.

**Flush doors:**  
Skipton | Central glass

**Planked doors:**  
Banbury | Central glass



Banbury



To bespoke your design visit our door designer...  
[door-designer.co.uk/safeguard](http://door-designer.co.uk/safeguard)



Canvas



Radiant



Satin

## Configurations



Wark

Peil

Eye

## Configurations



Skipton

Banbury

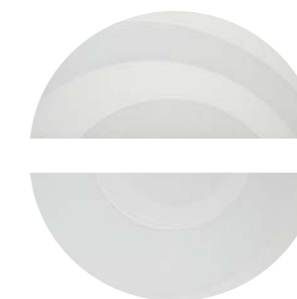

Eclipse



Tidal



Lunna

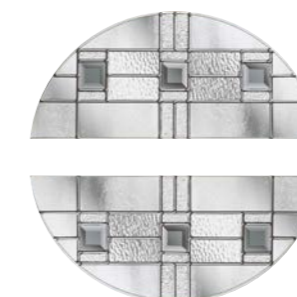

Aspen



Palma

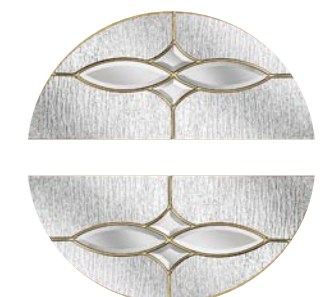

Scotia  
Zinc or Brass Caming

Colours shown should be used for guidance only as the limitations in the printing process may mean that colours vary from those illustrated.

# Orford

A great door design that lends itself to any type of property. Available on a flush or planked door.

The Orford door is shown here with Kara Clear glass in Azure Blue and stainless hardware.

**Flush doors:**

Orford | Central glass  
Barnard | Hinge aligned  
Lincoln | Handle aligned

**Planked doors:**

Painswick | Central glass  
Dursley | Hinge aligned  
Kemble | Handle aligned

Painswick • Dursley • Kemble



To bespoke your design visit our door designer...  
[door-designer.co.uk/safeguard](http://door-designer.co.uk/safeguard)



# Etal

A three panelled style to let in just the right amount of natural light but also provide privacy with a decorative glass design.

Featured left is the Etal door in Chartwell, with Valentia glass and stainless hardware.

**Flush doors:**

Etal | Central glass

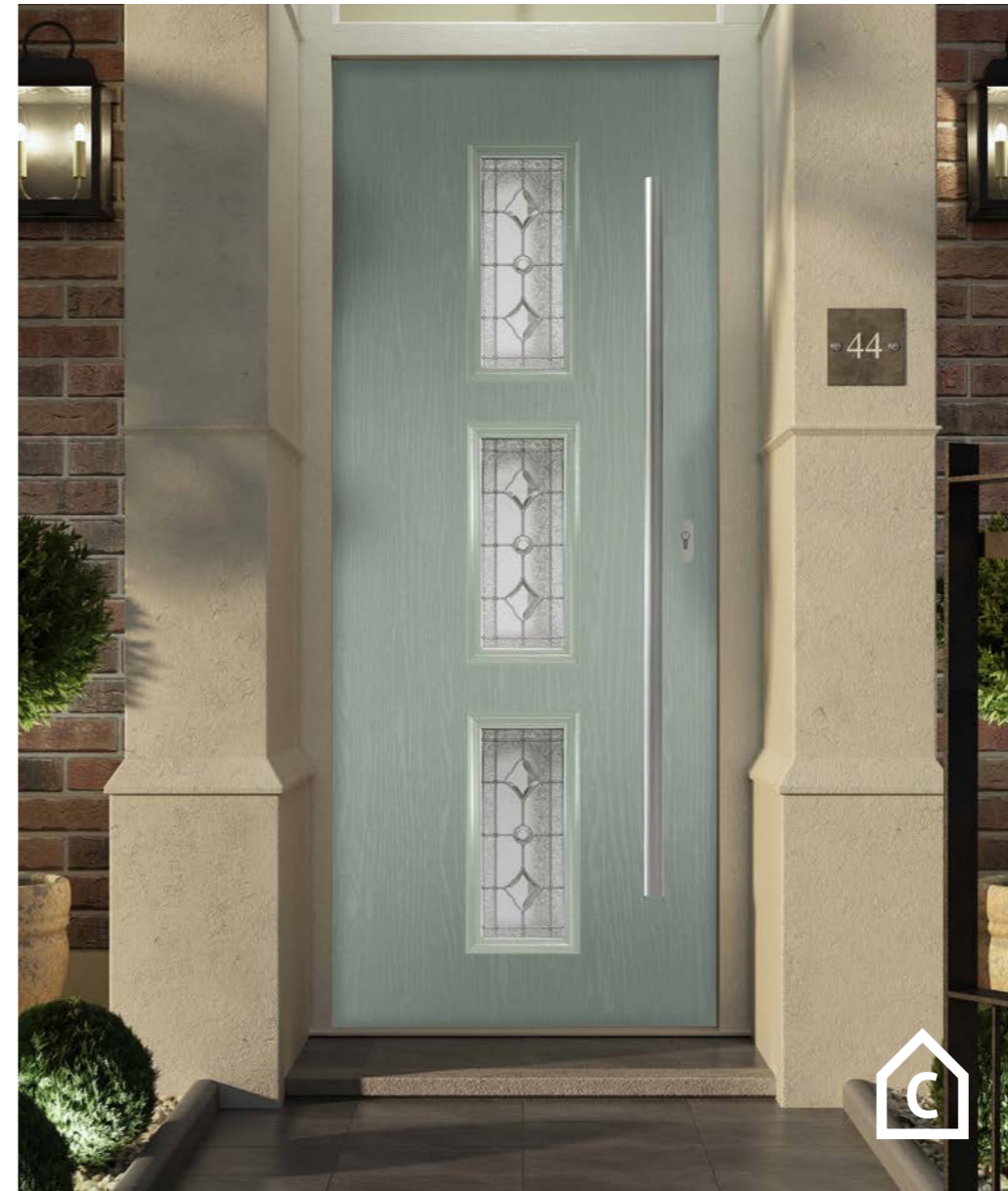

To bespoke your design visit our door designer...  
[door-designer.co.uk/safeguard](http://door-designer.co.uk/safeguard)

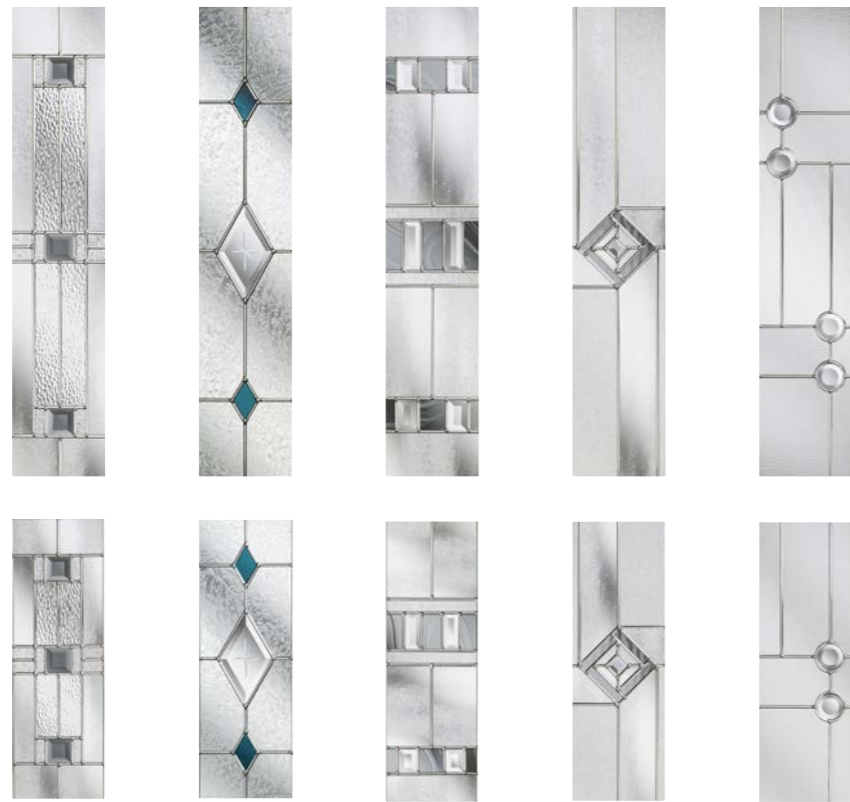

## Configurations



Orford Lincoln Barnard



Painswick Kemble Dursley

Aspen Kara Savana Sierra Trieste

Glass with Zinc or Brass Caming. Red/Blue/Green/ Grey - Zinc only.

## Configurations



Etal

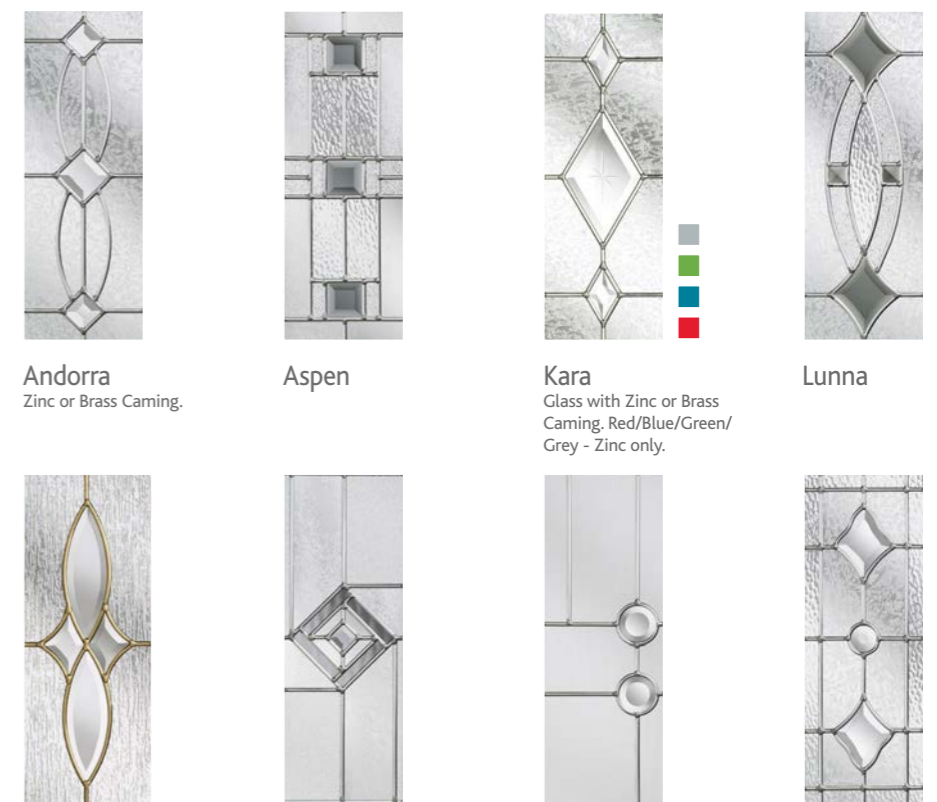

Andorra  
Zinc or Brass Caming.

Aspen

Kara  
Glass with Zinc or Brass Caming. Red/Blue/Green/ Grey - Zinc only.

Lunna

Scotia  
Zinc or Brass Caming.

Sierra

Trieste

Valentia

Colours shown should be used for guidance only as the limitations in the printing process may mean that colours vary from those illustrated.

# Astley

A great door design that lends itself to any type of property.

Featured right is our Astley door style in Ultramarine Blue with Nevis glass and stainless hardware.

### Flush doors:

Astley | Central glass  
Pickering | Hinge aligned  
Rufus | Handle aligned

To bespoke your design visit our door designer...  
[door-designer.co.uk/safeguard](http://door-designer.co.uk/safeguard)



# Solid Doors

A solid door provides perfect privacy and security for your home. Choose a bespoke colour to make it your own. Plus, our solid doors are highly energy efficient - it's one of the best choices you can make.

Willow door in Sable with stainless hardware.

To bespoke your design visit our door designer...  
[door-designer.co.uk/safeguard](http://door-designer.co.uk/safeguard)

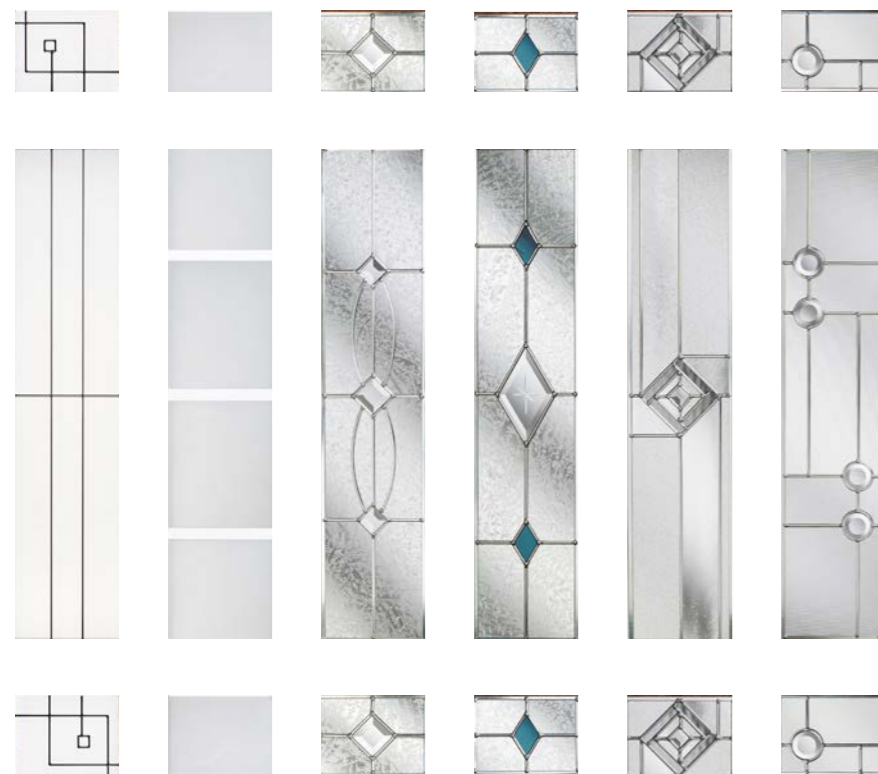
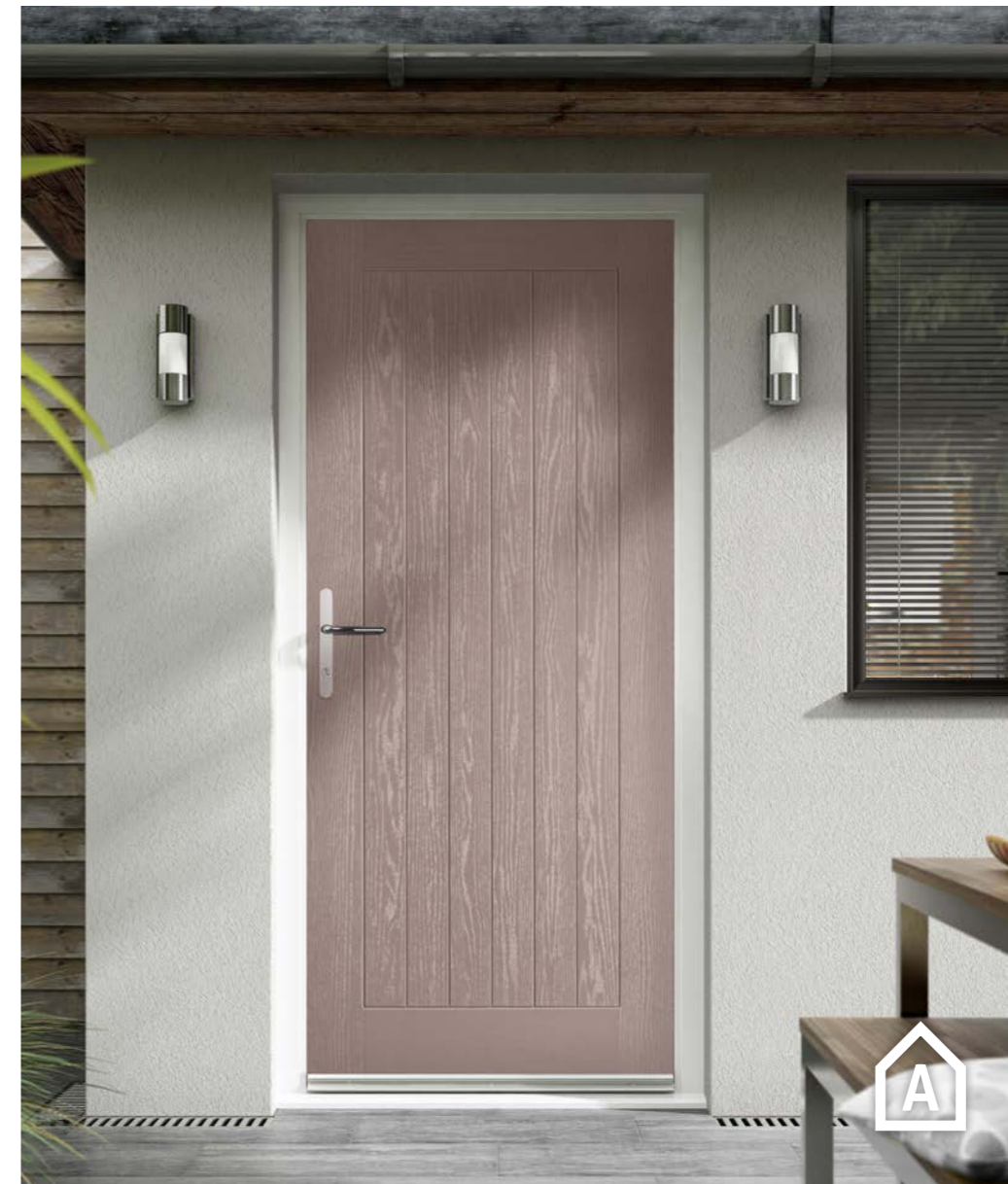

### Configurations



Astley

Rufus

Pickering

Matrix Nevis Andorra Kara Blue Sierra Trieste



Balmoral Solid

Alnwick Solid

Sherbourne Solid

Willow

Appleby

Colours shown should be used for guidance only as the limitations in the printing process may mean that colours vary from those illustrated.

# Double Doors

SafeGuard double doors make a grand entrance. Or alternatively they will give you just the functionality you desire from a set of French doors.

SafeGuard double doors are available in a variety of styles and colours and can help to give your home an incredibly regal feeling.

- These doors are one of the most popular features of any home
- Enjoy the added living and entertaining space, combines the indoors and outdoors
- Instantly adds value to your home
- Increases the natural light and ventilation
- Innovation that gives you all the benefits of the GRP composite door with a large glazing area too!



For the full colour range see page 45

# Sidelights

SafeGuard side panels have been designed to perfectly replicate the adjacent door and give your home the wow factor when installed.

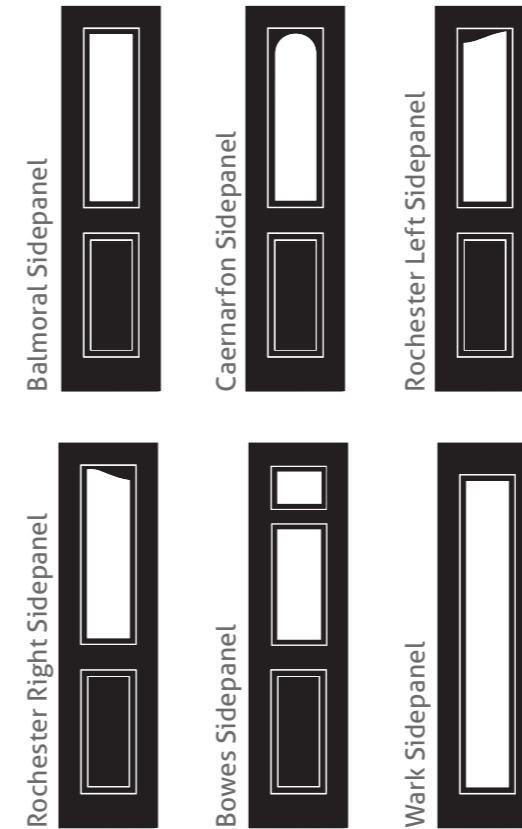

# Obscure Glass

We have various obscure glass options available, please ask your installer for more information.

To bespoke your design visit our door designer... [door-designer.co.uk/safeguard](http://door-designer.co.uk/safeguard)



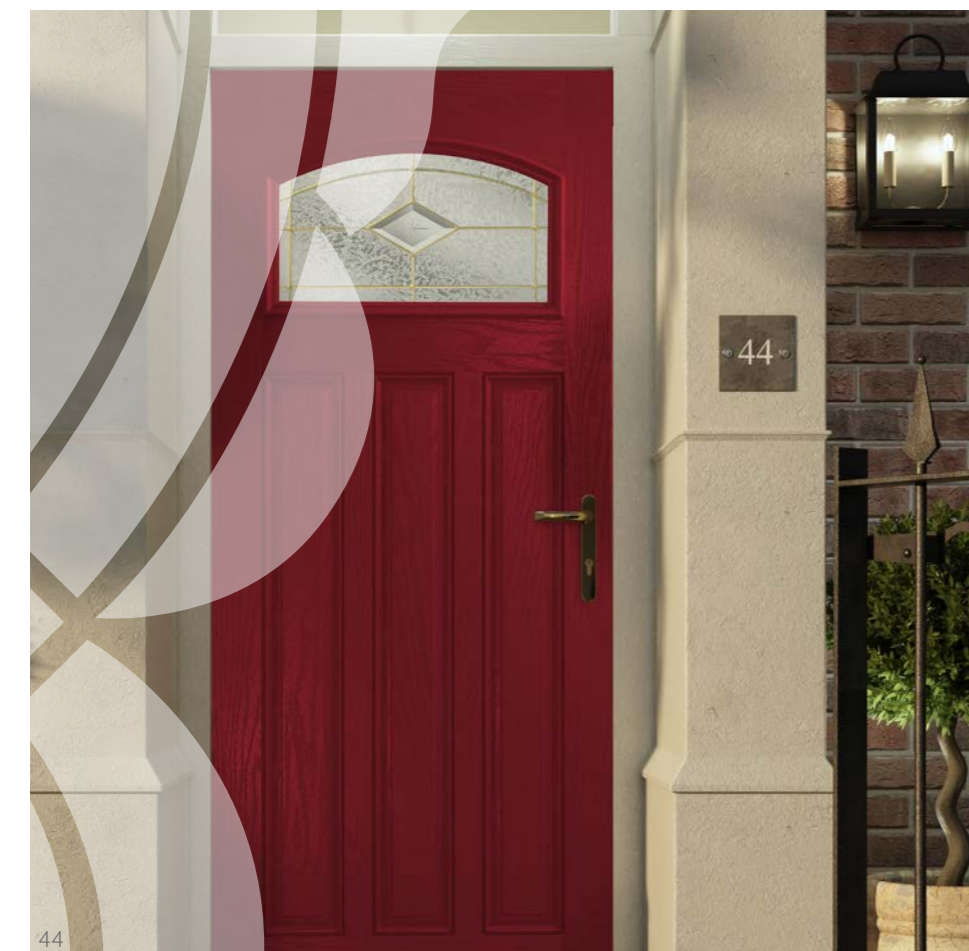





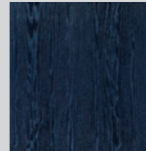
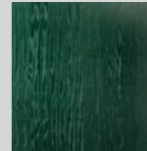
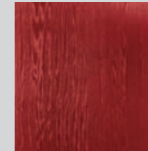

# Prestige Colour Range

			
RAL 7044 Silk Grey	RAL 9001 Cream	RAL 5002 Ultramarine Blue	BS 08 B 17 Honey Beige
			
RAL 7035 Light Grey	RAL 5023 Distant Blue	RAL 5024 Pastel Blue	BS 04 B 21 Sable
			
RAL 7042 Traffic Grey A	RAL 5009 Azure Blue	BS 16 C 33 Duck Egg	<b>NEW!</b> BS 454 Pale Roundel Red
			
RAL 7005 Mouse Grey	<b>NEW!</b> BS 12 B 17 Green Mist	RAL 3003 Ruby Red	RAL 3020 Traffic Red
			
RAL 7021 Black Grey	RAL 6002 Leaf Green	RAL 4007 Purple Violet	RAL 3005 Wine Red
			
<b>NEW!</b> SafeGuard Black Brown	RAL 1021 Colza Yellow	RAL 5011 Steel Blue	RAL 4008 Signal Violet

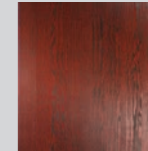
## Standard and stained options

								
Black	White	Blue	Green	Red	Gold Oak*	Rosewood*	Premium Chartwell	Premium Anthracite Grey

Colours shown should be used for guidance only as the limitations in the printing process may mean that colours vary from those illustrated.

# Hardware

No door is complete without some stunning hardware to finish it off. Our hardware is manufactured to internationally recognised standards, so you can be sure that every product is perfect, from how the hardware feels in your hand through to its functionality and finish.



We don't compromise on quality - each piece of hardware is engineered for enhanced strength and durability, whatever your style preference.

## Surface Finishes



White



Hardex Gold



Hardex Chrome



Hardex Graphite



Hardex Black



Antique Black



## Classic

Classic design for the modern home. Not overly fussy or fancy, our classic range offers neat, timeless style to suit any type of home.



## Heritage

Complementary styling for any period home. Ideal for big oak doors, heritage buildings and old cottages.



## More than just Matching

At SafeGuard, we give the smallest details our full attention to ensure we deliver a perfect product on every door and window.

- Prohesion Testing - Accelerated real world testing; Salt spray, cooling, heating & respraying
- Hardex Finish - Invisible skin that creates unmatched resilience
- Crafted Furniture - Engineered for enhanced strength and durability



# ULTION STAYS LOCKED

When the Ultion lock detects an attack, it goes into **Double Lockdown Mode™**  
A hidden attack lock secures the mechanism.

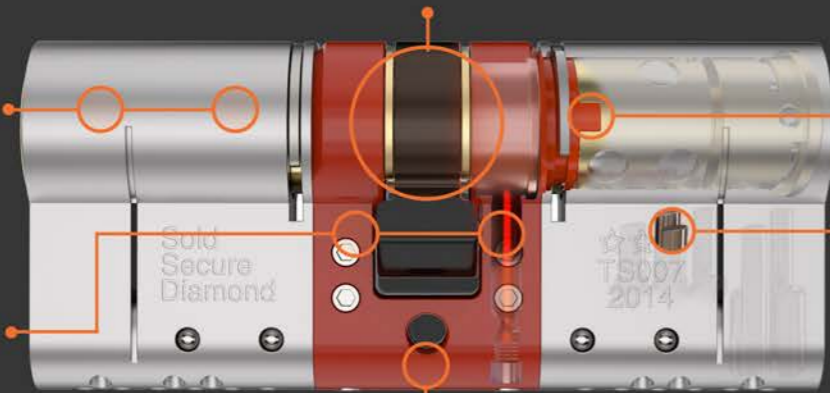

**Double Anti-Snap protection**  
The intruder needs to snap Ultion twice before he sees the core.  
**2 Attack locks**  
Lock still works from inside after an attack.

**2 Part Plug design**  
With molybdenum - stronger for longer.  
**20 Drill Defences**  
8 hardened steel rods and 2 plates in both ends.

**25%**  
Denser than iron  
The molybdenum core that houses the attack pins.

# BURGLAR-PROOF YOUR DOORS

**75%**  
of intruders go through the door



**39%**  
get through the door by forcing the lock



## How locks are forced



## Every body approves.



Approved by locksmiths

Few locks survive the test designed with the Master Locksmith Association and carried out by locksmiths.



Approved by the Police

The official UK Police flagship initiative combining the principles of 'designing out crime' with physical security.



Approved by British Standards

Kitemark is the standard of excellence recognised around the world. Ultion is accredited with the highest 3 star rating.



We'll pay you **£1000**

If an intruder burgles your home by snapping Ultion, we'll pay you £1000

ACTIVATE FOR FREE  
[www.ultion.co.uk](http://www.ultion.co.uk)

Prevent keys being copied without your permission

**ULTION**  
**KEY CONTROL**



## Technical Figures

A SafeGuard GRP composite door has a wealth of facts and figures that prove its quality. The door:

- Reduces outdoor noise by an average of 31dB
- Achieves Global Warming Potential (GWP) score of less than 5
- Achieves Ozone Depletion Potential (ODP) score of zero
- The door leaf and glazing system are major components when part of a door set and have a proven ability to achieve PAS24:2016, industry's enhanced security standard, a prerequisite in attaining certification to Secured by Design a police initiative to protect against unlawful intrusion

Everything about a SafeGuard GRP composite door has been designed to enhance your home for years to come.



## Care and Maintenance

To keep your door clean, prolong the life of the surface finish and protect your warranty, we recommend you wash it regularly using warm soapy water (washing up liquid is ideal) and a soft, lint-free cloth. If you live in a coastal area, in a heavily industrialised area or near a main road, you may need to clean your door more frequently.

It is important that you DO NOT use any of the following on your door:

- Abrasive cleaners or scouring pads
- Any type of bleach or solvent (e.g. white spirit, methylated spirit, cellulose thinners, acetone or nail varnish remover)
- Any type of adhesives or tack for providing temporary protection or fixing of seasonal or other decorations etc.
- High pressure or steam cleaners

## Door Construction

Every SafeGuard GRP composite door is manufactured to the highest of standards to ensure it is strong, durable and secure. We have sold over four million doors to date, evidence of the quality and exacting specification we demand.

The door has a perimeter sub-frame of a solid, water-resistant polymer material, which is reinforced with Laminated Veneered Lumber (LVL). A thermoset GRP skin is bonded to this sub-frame and the core of the door is then filled with high density, 100% CFC-free polyurethane foam. Water resistant polymer composite rails protect the core from damage or water absorption and the high impact resistant thermoset GRP skin keeps your door looking great for longer!

The door's core is what makes it so thermally efficient and so good at reducing sound. In fact, it is the most thermally efficient door on the market, increasing your home's energy efficiency and saving you money on your energy bills.



**SafeGUARD**  
COMPOSITE DOORS

All information in this publication is provided for guidance only and is given in good faith. SafeGuard reserve the right to alter specifications without prior notice. All images are for illustration purposes only. SafeGuard have a policy of continuous improvement and reserve the right to change specification and designs at any time without notice. Please check with your installer prior to ordering to confirm availability of your specification requirements. SafeGuard Composite Door Collection Brochure Jun 2020. Copyright © Distinction Doors 2020.